

Data Sheet



Article number: 339702320000

Description: Multibeam 6 Coupling 702.32.0000
St. steel & set screw hubs

Measures

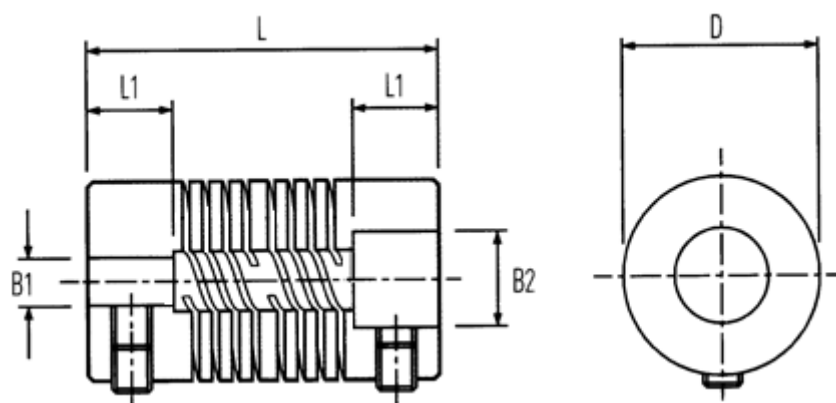

B1: Pre-drilled	= 8.0
B2: Pre-drilled	= 10.00
D	= 31.8
L	= 57.2
L1	= 16.0
Max angular displacement	= 0.50
Max B1 & B2	= 19.00
Max parallel displacement	= 7

Peak Torque NM	= 25.00
Set Screw	= M6